

PUERTA

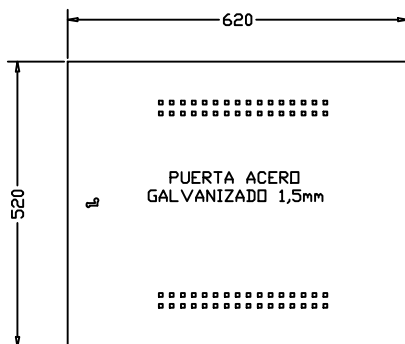

MARCO

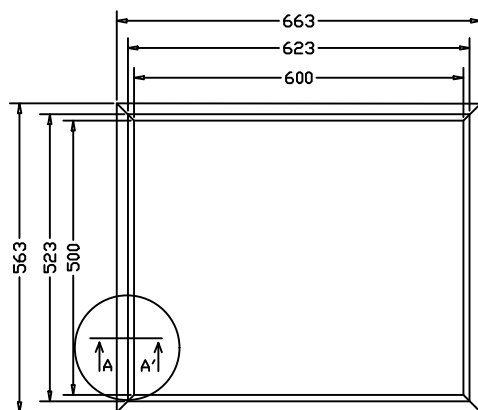

CONJUNTO

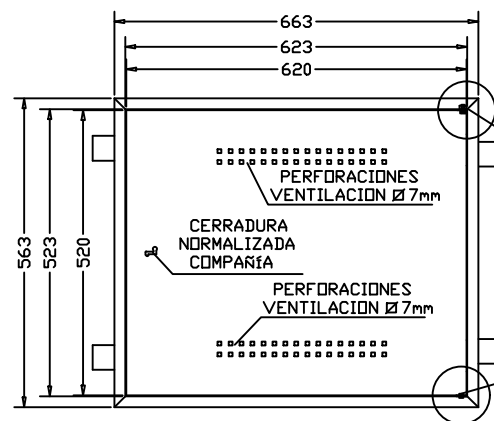

PERFIL CONJUNTO

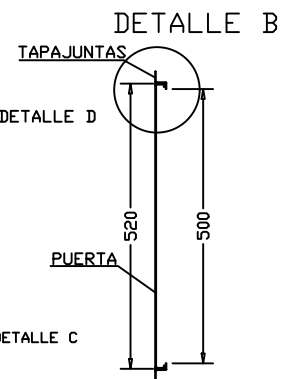

DETALLE A

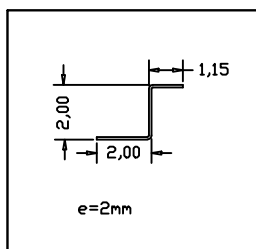

DETALLE B

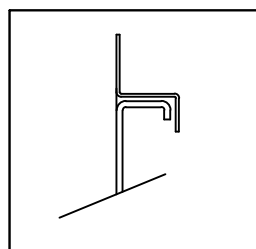

DETALLE C

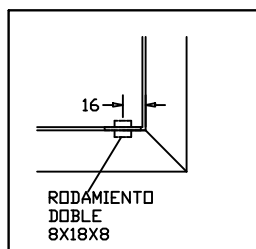

DETALLE D

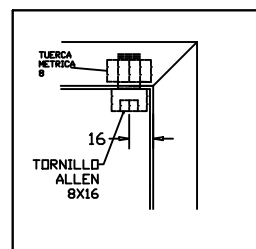

ARQUETAS
SOLUCIONES ESTÁNDAR Y A MEDIDA

FICHAS TÉCNICAS ARQUETAS

ARTÍCULO
PUERTA D-2

ESCALA	FECHA	Nº PLANO
1/100	FEB 2022	24

C/ MARACAIBO, 22A
08030 BARCELONA
934572135 - info@arquetas.es